

# VANTAGE AIR

18865 GOLL ST. - SAN ANTONIO, TX - 78266 - ph 210-654-7171 - fax 210-654-3113

## MINI SPACE SAVER HEAT / COOL

01000-QUX-A  
01000-VUX-A

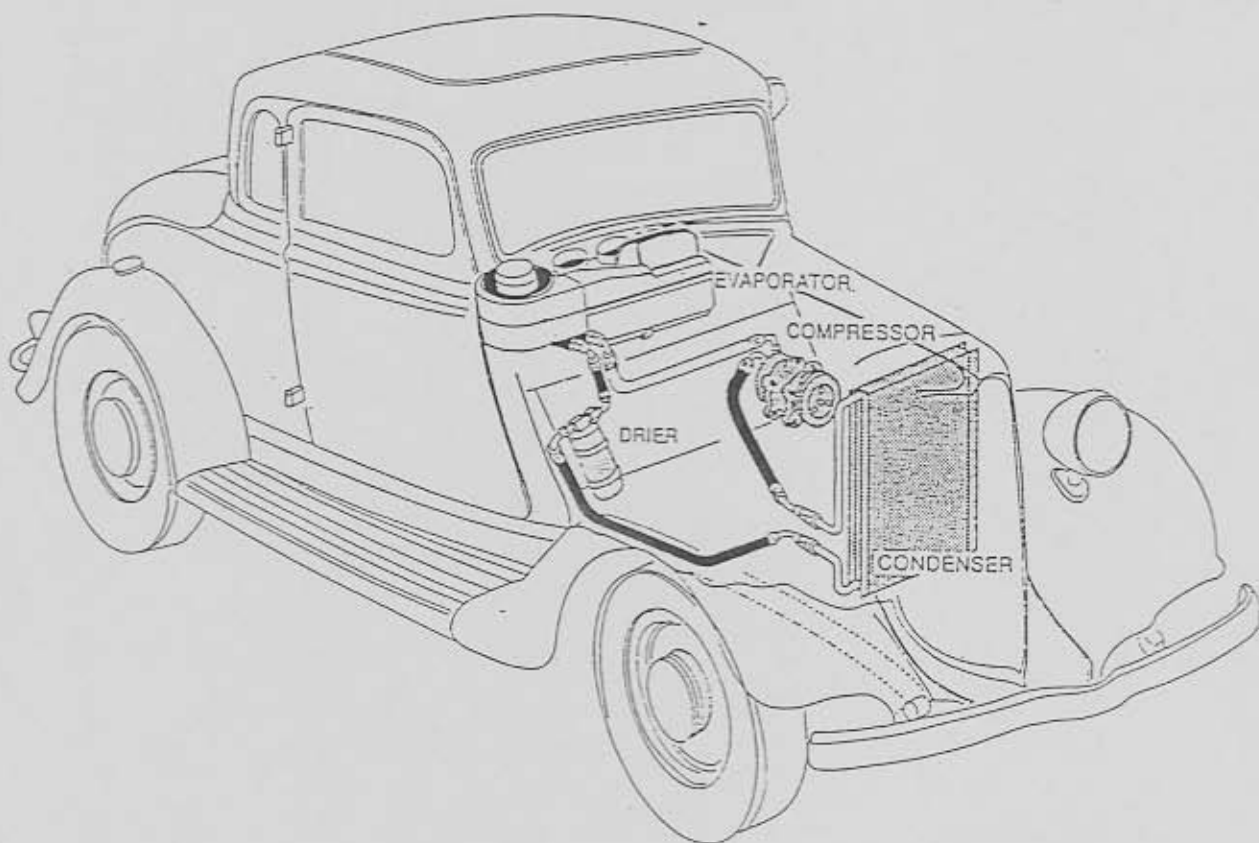

## **TABLE OF CONTENTS**

### PAGES

1. COVER
2. TABLE OF CONTENTS
3. PACKING LIST
4. INFORMATION PAGE
5. PASSENGER COMPARTMENT
6. EVAPORATOR INSTALLATION
7. A/C LINES AND FITTINGS INSTALLATION
8. CONTROL PANEL INSTALLATION
9. HEATER HOSE ROUTING/INSTALLATION
10. A/C HOSE ROUTING
11. HOSE ROUTING ILLUSTRATION
12. WIRING DIAGRAM
13. ADJUSTING THERMOSTAT
14. EVAPORATOR KIT PACKING LIST

## EVAPORATOR KIT PACKING LIST

EVAPORATOR KIT  
01000-QUX-A  
01000-VUX-A

No.	QTY.	PART No.	DESCRIPTION
1.	1	55302-VUE-A	EVAPORATOR SUBCASE
2.	1	63250-VUE	I K KIT
3.	8	06250-VUE	2 1/2" DUCT HOSE
4.	1	63512-KUB	EVAPORATOR MTG. KIT
5.	1	_____	CONTROL PANEL w/ WIRING
6.	1	_____	VENTS
		_____	OPTIONAL VENTS
		_____	OPTIONAL VENTS

**\*\* BEFORE BEGINNING INSTALLATION OPEN ALL PACKAGES AND CHECK CONTENTS OF SHIPMENT. PLEASE REPORT ANY SHORTAGES DIRECTLY TO VINTAGE AIR WITHIN 15 DAYS. AFTER 15 DAYS, VINTAGE AIR WILL NOT BE RESPONSIBLE FOR MISSING OR DAMAGED ITEMS.**

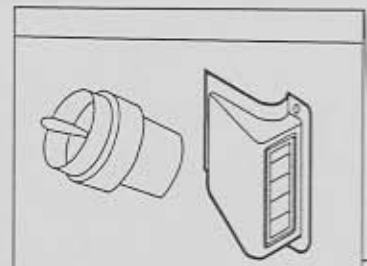
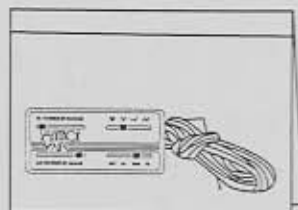
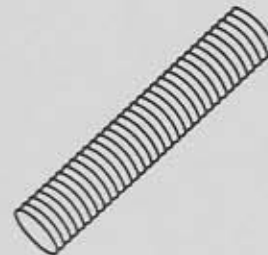
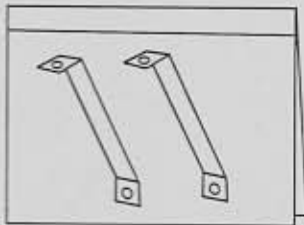
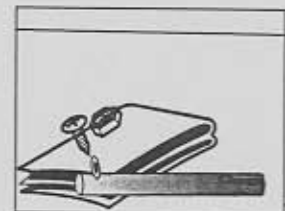
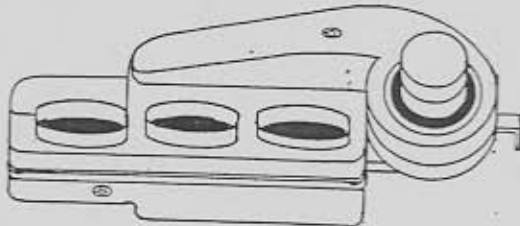

# MINI SPACE SAVER

## HEAT/COOL

### IMPORTANT NOTICE-PLEASE READ

**FOR MAXIMUM SYSTEM PERFORMANCE  
VINTAGE AIR RECOMMENDS THE FOLLOWING:**

#### **SAFETY SWITCHES:**

VINTAGE AIR ALWAYS RECOMMENDS AN OPTIONAL COMPRESSOR SAFETY SWITCH BE INSTALLED ON EVERY A/C SYSTEM. A BINARY SWITCH (PART # 24679-VUS) DISENGAGES THE COMPRESSOR CLUTCH IN CASE OF EXTREME LOW PRESSURE CONDITION (REFRIGERANT LOSS) OR EXCESSIVELY HIGH HEAD PRESSURE (406 PSI.), TO PREVENT COMPRESSOR DAMAGE OR HOSE RUPTURE. A TRINARY SWITCH (PART# 24678-VUS) COMBINES HI/LO PRESSURE PROTECTION WITH AN ELECTRIC FAN OPERATION SIGNAL AT (254 PSI.) COMPRESSOR SAFETY SWITCHES ARE EXTREMELY IMPORTANT SINCE AN A/C SYSTEM RELIES ON REFRIGERANT TO CARRY LUBRICATION THROUGH THE SYSTEM.

#### **SERVICE INFO:**

EVACUATE THE SYSTEM FOR 35-45 MINUTES WITH SYSTEM COMPONENTS (DRIER, COMPRESSOR, EVAPORATOR AND CONDENSER) AT A TEMPERATURE OF AT LEAST 85° F. ON A COOL DAY THE COMPONENTS CAN BE HEATED WITH A HEAT GUN OR BY RUNNING THE ENGINE WITH THE HEATER ON BEFORE EVACUATING.

LEAK CHECK AND CHARGE TO SPECIFICATIONS.

**THE PROPER AMOUNT OF REFRIGERANT IS CRITICAL TO PROPER SYSTEM OPERATION. VINTAGE AIR RECOMMENDS OUR SYSTEMS BE CHARGED BY WEIGHT WITH A QUALITY CHARGING STATION OR SCALE.**

#### **REFRIGERANT CAPACITIES**

##### **134a SYSTEM**

CHARGE WITH 1.8 LBS. OF REFRIGERANT

##### **R-12 SYSTEM**

CHARGE WITH 2.0 LBS. OF REFRIGERANT

#### **LUBRICANT CAPACITIES**

NEW COMPRESSOR - NO ADDITIONAL OIL NEEDED  
USED COMPRESSOR - CONSULT VINTAGE AIR

**INSTALLATION INSTRUCTIONS**  
**MINI/SPACE SAVER**  
**HEAT/COOL**

The Vintage Air "Mini/Spacesaver" Heat & Cool was designed especially for your street rod. It will fit neatly behind the dash of your car out of sight. Read the directions completely and remove all parts from box, to identify each of them with packing list.

The installation of this unit varies according to the body manufacturer or modifications to original body. The cowl vent may remain operational. (see step 2 below) Take your time, double check before drilling or cutting.

THE EVAPORATOR WAS DESIGNED TO FIT ON THE PASSENGER SIDE.

1. Before beginning remove cowl vent handle and glove box to ease installation. If the dash is easily removable remove it now. Check for and fill in any holes in the firewall and floor. Insulate and seal firewall, floor, door panels and head liner to reduce the amount of heat entering into the car.
2. The evaporator should fit with blower motor toward the top of the cowl. Duct hoses outlets face upper cavity. Drain outlet is always on the bottom (down)side of the evaporator, see figure 1 below.

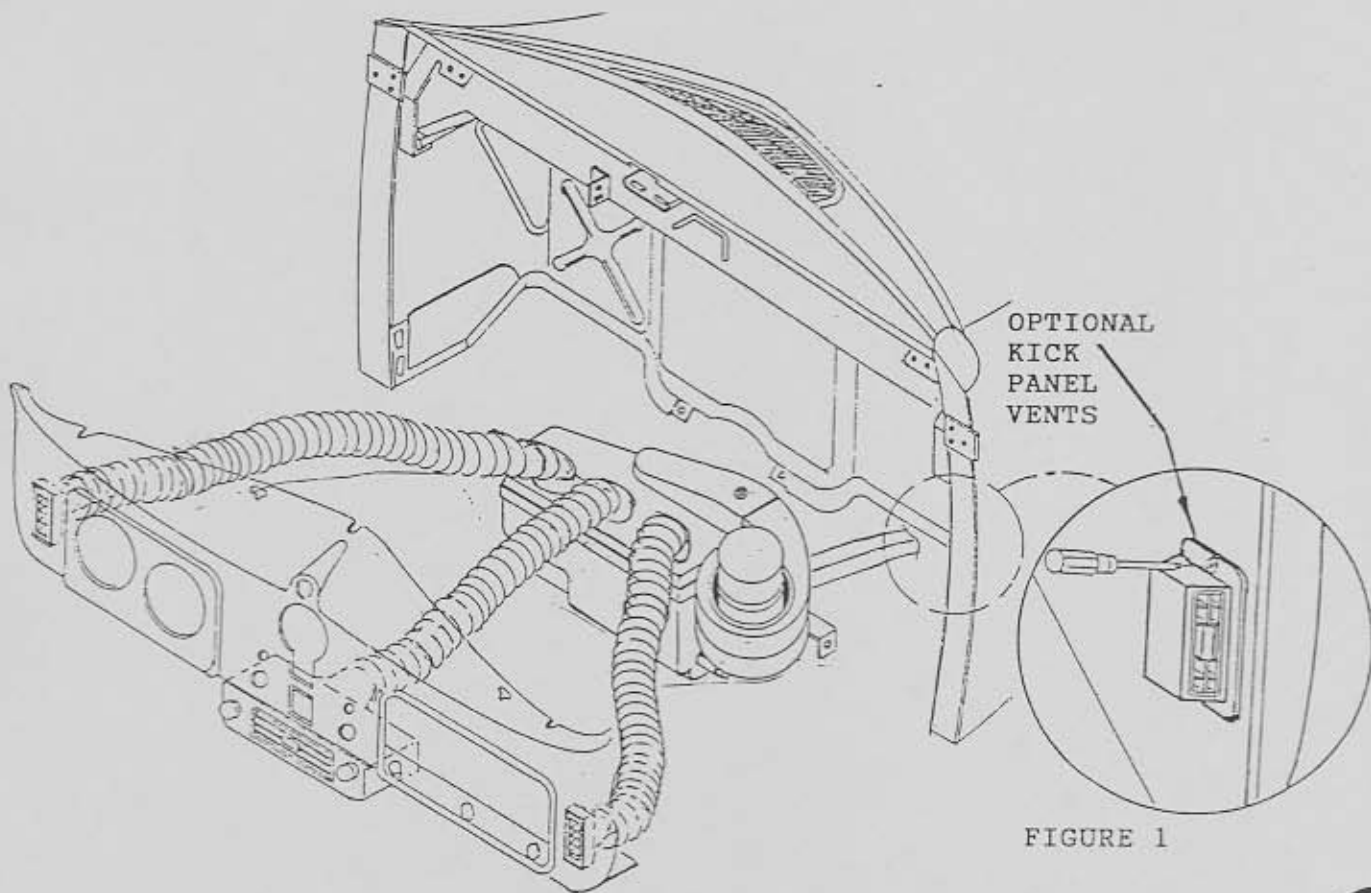

3. Brackets are furnished to mount the evaporator case using the cowl vent. (Attach to firewall as shown). Figure 2

4. The cowl vent handle will work if moved to the side. You can also convert to electric or cable operation. If you close off the cowl vent the unit will fit higher in the car. NOTE: To mount unit higher, simply determine the new location, mark and redrill the bracket to fit as described in Step 6. Figure 2

5. When fitting evaporator:

- A. Remove blower motor cover.
- B. Attach front and rear brackets to the evaporator using 1/4 - 20 X 1/2" bolts.
- C. Fit refrigeration fittings with hoses for proper clearance inside the car. (Refer to hose routing instructions Page 11.)

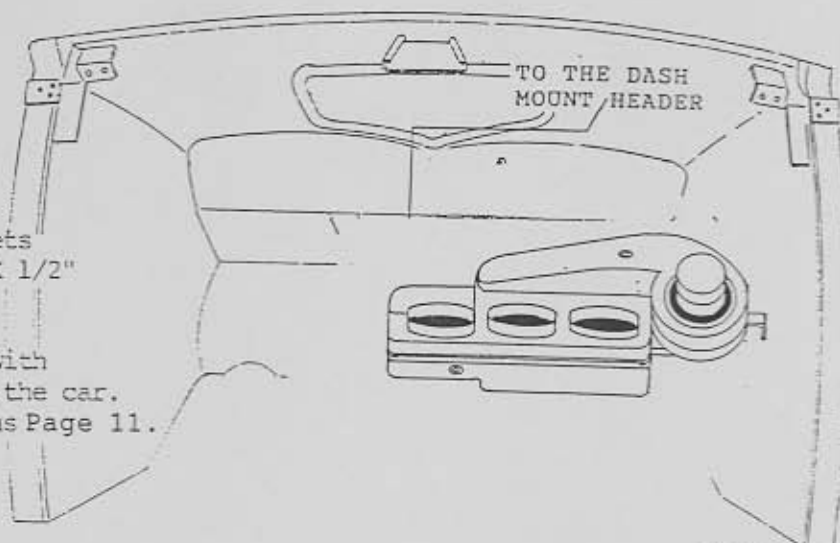

FIGURE 2

6. Have a helper hold the unit up as high as possible, with blower housing against passenger side kick panel. Locate the bracket on the top right side of the blower housing. Scribe thru the 1/4" hole in the bracket to mark the firewall. Check to see if the location you marked looks ok and will clear obstructions on both sides of the firewall. If so, drill 9/32" hole in the firewall. Attach the evaporator to the firewall by the blower motor bracket with a 1/4-20 x 1" bolt and nut. Using the rear evaporator bracket as a guide mark and drill thru the 1/4" hole in the bracket. Attach this bracket to the firewall with a 1/4-20x1" bolt and nut. This will locate the evaporator horizontally. Now secure the front-evaporator support strap to the unit with the 1/4 - 20 X 1/2" bolt. This support bracket will attach to the dash mount header. With the unit held in place and level mark thru the 1/4" hole at the top of the bracket. To the sheet metal header. Make sure that the spot marked will provide a good mounting location for this bracket. Drill a 9/32" mounting hole. Secure the mount strap to the cowl header as shown in Figure 2 with 1/4-20 x 1" bolt and nut.

NOTE: The vents that are being used should be in place at this time.

7. The duct hose should be put on the evaporator at this point and run to the vents to insure proper clearance. See figure 1, page 5.



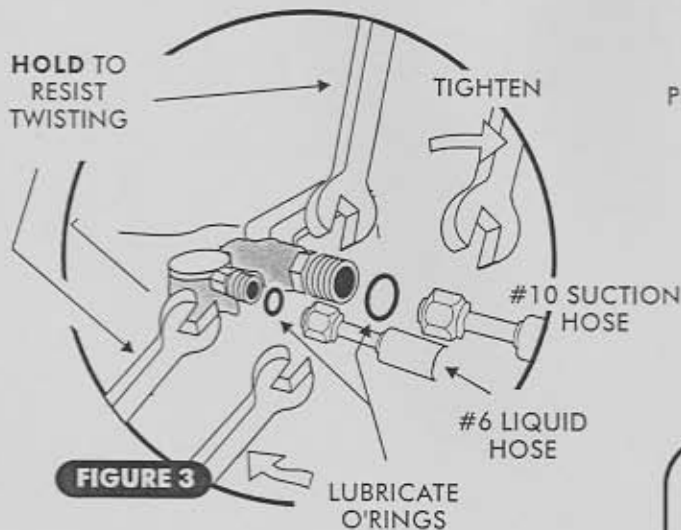

**FIGURE 3**

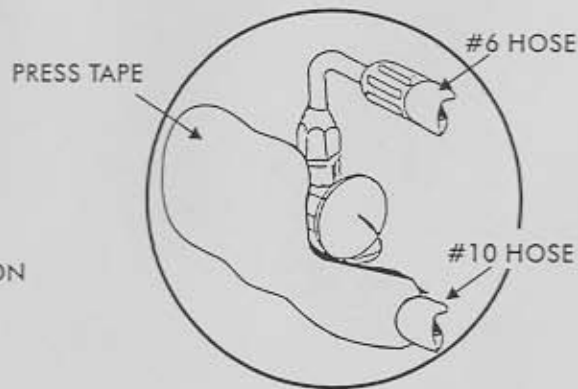

**FOR A PROPER SEAL OF FITTINGS INSTALL SUPPLIED O'RINGS AS SHOWN AND LUBRICATE WITH SUPPLIED OIL.**

O-RING, SLIDE OVER MALE INSERT TO SWAGED LIP  
 SUPPLIED OIL FOR O'RINGS



**FIGURE 3A**

8. INSERT THE CAPILARY TUBE INTO THE COIL THRU THE LOCATION STICKER LOCATED ON TOP OF THE EVAPORATOR TO A DEPTH OF 4½". WITH REFRIGERATION HOSES AND DUCT HOSES ON THE UNIT, LIFT IT IN PLACE. MAKE SURE THAT THE FIREWALL FITTINGS ARE ACCESSIBLE WITH THE UNIT IN PLACE. IF NOT, TIGHTEN ALL REFRIGERATION FITTINGS INSIDE THE CAR NOW, WHILE YOU CAN REACH THEM. LIFT THE UNIT INTO PLACE, AND TIGHTEN THE BRACKET BOLTS TO SECURE TO THE EVAPORATOR.
9. ROUTE HEATER HOSES (REFER TO HEATER HOSE ROUTING INSTRUCTIONS, PG. 9).
10. WITH YOUR UNIT IN PLACE, STRETCH THE DUCT HOSE TIGHTLY TO THE DASH VENT, AND RECHECK THE LENGTH. TRIM TO ENSURE THAT THE HOSE IS ENSURED TAUT, WITH A MINIMUM OF KINKS OR SHARP BENDS IN THE HOSE. THIS WILL ENSURE MAXIMUM AIRFLOW.
11. MAKE ELECTRICAL AND/OR VACUUM CONNECTIONS, ACCORDING TO THE DIAGRAM FURNISHED ON PG. 12.

**NOTE:** THE RED 12GA. WIRE WITH THE 30 AMP CIRCUIT BREAKER SHOULD BE CONNECTED TO A 12 VOLT POWER SOURCE OF AT LEAST 12GA. WIRE. CONNECT MOLDED PLUG WITH THE (RED, YELLOW, ORANGE) WIRES TO THE CORRESPONDING PLUG FROM THE BLOWER MOTOR. THE RED WIRE FROM THE BLOWER MOTOR WITH THE WHITE EXTENSION AND RING TERMINAL MUST BE GROUNDED. THE BLUE AND YELLOW WIRES FROM THE BLOWER MOTOR MUST BE PLUGGED TOGETHER. THE BLUE CLUTCH WIRE RUNS FROM THE THERMOSTAT TO THE COMPRESSOR SAFETY SWITCH AND FROM THE SAFETY SWITCH TO THE COMPRESSOR.

**BE CAREFUL TO ENSURE THAT THIS WIRE IS NOT PINCHED OR IN A POSITION TO RUB ON A SHARP EDGE AS IT GOES THRU THE FIREWALL. AN OPTIONAL VACUUM RESERVOIR WITH CHECK VALVE WILL HELP SYSTEM WORK UNDER A VARIETY OF CONDITIONS. (VINTAGE AIR PART #31200-VUS VACUUM RESERVOIR).**

- IF PREVIOUSLY REMOVED, REINSTALL DASH AND INSURE THAT THE DUCT HOSE IS SECURELY ON THE DASH VENT HOSE ADAPTERS.
- **DON'T FORGET TO WRAP ANY EXPOSED #10 FITTINGS INSIDE THE CAR TO PREVENT CONDENSATION.**

### CONTROL PANEL OPERATION

IF YOU ARE USING AN OPTIONAL CONTROL PANEL, REFER TO THE INSTRUCTIONS FURNISHED WITH THE PANEL FOR OPERATION. CHECK OPERATION (SEE FIGURE 4).

- THE SWITCH ON THE LEFT IS THE FAN SWITCH - CONTROLS 3 SPEED FAN MOTOR.
- THE SWITCH ON THE RIGHT IS THE MODE SELECTION. FULL COUNTER-CLOCKWISE POSITION IS ECONOMY POSITION. AMBIENT TEMPERATURE AIR SHOULD COME OUT OF DASH VENTS. IN THE FIRST POSITION (A/C POSITION), COLD AIR SHOULD COME OUT OF THE DASH VENTS. THE SECOND POSITION (HEAT POSITION), HOT AIR SHOULD COME OUT OF THE FLOOR VENT. IF VACUUM OPERATED, THE HEATER CONTROL VALVE SHOULD BE RECEIVING A VACUUM SIGNAL AND BE OPEN.

FAN SPEED CAN BE OPERATED IN ANY MODE POSITION

**NOTE: WHEN IN DEFROST MODE POSITION TURN THERMOSTAT KNOB FULL COUNTER CLOCKWISE AND THEN CLOCKWISE 1/8 TURN OR UNTIL THERMOSTAT CLICKS ON, THIS WILL GIVE OPTIMUM DEFROST PERFORMANCE.**

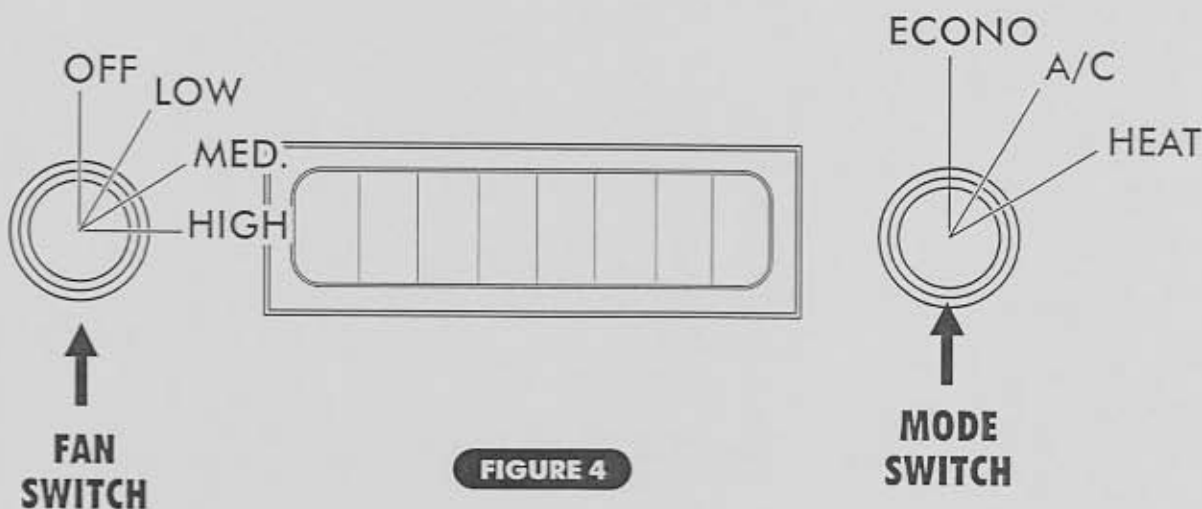

**FIGURE 4**



## HEATER HOSE INSTALLATION

• AFTER THE EVAPORATOR IS IN PLACE, RUN 5/8" HEATER HOSE FROM THE HEATER TUBE NEAREST THE BLOWER ON THE EVAPORATOR THRU THE FIREWALL OR BEHIND THE KICK PANEL THRU FLOOR TO THE INTAKE MANIFOLD HEATER CONNECTION. INSTALL THE HEATER CONTROL VALVE IN THIS LINE. (PRESSURE) SEE FIGURE BELOW. **(BE SURE TO FOLLOW FLOW ARROW ON HEATER CONTROL VALVE)**

• INSTALL 5/8" HEATER HOSE ON THE REMAINING HEATER TUBE. ROUTE HOSE THRU FIREWALL OR BEHIND KICK PANEL THRU FLOORBOARD AND OUT TO WATER PUMP CONNECTION. (SUCTION)

**FILL RADIATOR WITH AT LEAST A 50/50 MIXTURE OF APPROVED ANTIFREEZE AND WATER. IT IS THE OWNER'S RESPONSIBILITY TO KEEP THE FREEZE PROTECTION AT THE PROPER LEVEL FOR THE CLIMATE IN WHICH THE VEHICLE IS OPERATING. FAILURE TO FOLLOW ANTIFREEZE RECOMMENDATIONS WILL CAUSE HEATER CORE TO CORRODE PREMATURELY AND POSSIBLY BURST IN THE A/C MODE AND/OR FREEZING WEATHER, VOIDING YOUR WARRANTY. CHECK COMPLETE A/C ASSEMBLY FOR PROPER OPERATION. VINTAGE AIR RECOMMENDS THAT ALL A/C SYSTEMS BE SERVICED BY A CERTIFIED AUTOMOTIVE AIR CONDITIONING TECHNICIAN ONLY. SEE INSIDE COVER FOR SERVICE INFORMATION.**

• START ENGINE AND RUN, UNTIL NORMAL OPERATING TEMPERATURE IS REACHED. PLACE SWITCH IN HEAT POSITION (SEE FIGURE 4, PAGE 8), AND SELECT FAN SPEED DESIRED. THE SYSTEM WILL HEAT THE VEHICLE. **IMPORTANT: (BE SURE THE ENGINE THERMOSTAT HAS OPENED, AND THE APPROVED ANTIFREEZE MIXTURE HAS BEEN CIRCULATED THRU THE HEATER CORE BEFORE TESTING THE A/C MODES).**

• WHEN VALVE IS CLOSED, INLET SIDE OF VALVE SHOULD BE HOT AND OUTLET SIDE SHOULD BE COOL. WHEN THE VALVE IS OPEN, BOTH INLET AND OUTLET SIDES SHOULD BE HOT.

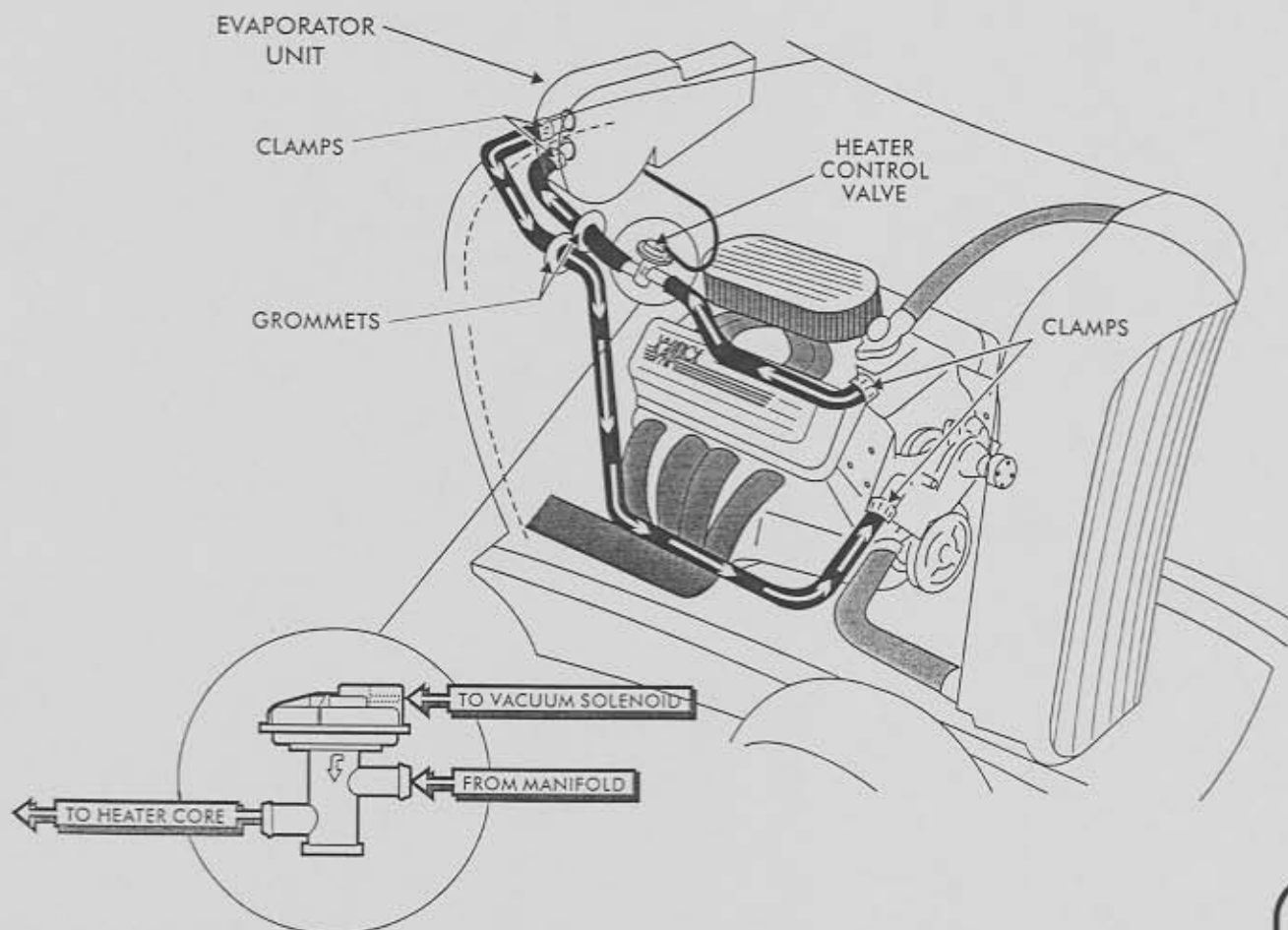

- PUSH THE 5/16" I.D. HOSE ONTO THE STRAIGHT #6 FITTING. (SEE HOSE ROUTING ILLUSTRATION ON PG. 11). INSTALL THE FITTING ONTO THE EXPANSION VALVE (FINGER TIGHT). PUSH THE 1/2" I.D. HOSE ONTO THE STRAIGHT #10 FITTING, AND INSTALL THE FITTING ONTO THE #10 LINE ON THE EVAPORATOR. (SEE HOSE ROUTING ILLUSTRATION PG. 11).
- AT THIS TIME, TRY TO DETERMINE WHERE YOU WANT YOUR LINES TO GO THRU THE FIREWALL. MOVE THE HOSES TO THAT POINT. HOLD THE FITTINGS UP TO THEIR RESPECTIVE HOSES, AND DETERMINE IF THE HOSES WILL CONFORM TO THE LOCATION FOR THE BULKHEAD FITTINGS OR OPTIONAL BULKHEAD PLATE (VINTAGE AIR PART #34215-VUQ OR 34217-VUQ). THE 1/2" HOSE IS HARD TO BEND AT A SHARP ANGLE, AND THE FITTINGS TAKE UP A CERTAIN AMOUNT OF SPACE. BEFORE YOU DRILL HOLES IN YOUR FIREWALL, MAKE SURE THAT YOU CAN MAKE THE HOSES FIT WHERE YOU HAVE PLANNED. THE ENGINE COMPARTMENT APPEARANCE IS A CONSIDERATION WHEN CHOOSING THIS LOCATION.
- WHEN YOU HAVE DECIDED WHERE YOU WANT TO PLACE YOUR BULKHEAD FITTINGS, MARK THESE POINTS WITH A GREASE PENCIL, AND MAKE A TEMPLATE FROM THE INSIDE LOCATING WHERE THE HOLES WILL BE CUT. WITH THIS TEMPLATE, LOCATE THE SAME POINTS ON THE OUTSIDE OF THE FIREWALL. MARK THESE POINTS WITH A GREASE PENCIL.
- DETERMINE THE BEST LOCATION FOR THE DRIER THAT WILL ALLOW ADEQUATE ROOM FOR THE HOSE AND FITTINGS THAT CONNECT THE DRIER TO THE BULKHEAD FITTING.
- MOUNT THE DRIER. (KEEP THE DRIER CAPPED AS MUCH AS POSSIBLE, IF YOU MUST SCREW THE FITTING TO THE DRIER, TAPE IT CLOSED).

**NOTE: THE DRIER IS USUALLY MOUNTED WHERE YOU HAVE ROOM FOR IT. JUST REMEMBER TO MOUNT IT IN THE COOLEST SPOT POSSIBLE AND VERTICALLY SO THE SIGHT GLASS IS DIRECTLY ON TOP. (NOT NEXT TO THE EXHAUST MANIFOLD). IT CAN BE MOUNTED INSIDE THE VEHICLE AS WELL.**

- AT THIS POINT, CUT HOLES FOR BULKHEAD FITTINGS, AND INSTALL THEM.
- USING THE HOSE ROUTING ILLUSTRATION AS A GUIDE, ROUTE REMAINING A/C LINES, AND CUT TO LENGTH.
- INSTALL A/C VENTS THAT WILL BE USED AT THIS TIME.
- CENTER OUTLET: YOU MAY USE THE CENTER PANEL FURNISHED, OR YOU CAN MOUNT THE VENTS IN DASH. IF YOU USE THE CONTROL PANEL, THE TOP MOUNTING LIP SHOULD BE BACK 1/4" x 1/2" FROM LOWER LEADING EDGE OF DASH. LOCATE THE 2 1/2" I.D. HOSE, AND ROUTE FROM THE DASH VENTS TO THE EVAPORATOR.
- AT THIS TIME, YOU SHOULD HAVE THE REFRIGERATION HOSES CUT TO THEIR PROPER LENGTH. **PAY CLOSE ATTENTION TO THE ORIENTATION OF ANY HOSE WITH TWO ANGLED FITTINGS.** ANY HOSE WITH TWO ANGLED FITTINGS MUST BE MARKED FROM THE HOSE TO THE FITTINGS TO ASSURE THEY WILL REMAIN IN THIS POSITION AFTER CRIMPING. THE RUBBER HOSE IS ONLY CAPABLE OF A MINIMAL AMOUNT OF TWIST TO AID ALIGNMENT.
- REMOVE HOSES AND CRIMP ENDS. IF YOU DO NOT HAVE ACCESS TO THE PROPER EQUIPMENT, YOU MUST TAKE THEM TO A QUALIFIED A/C SERVICE CENTER FOR CRIMPING. (SEE CRIMPING INSTRUCTIONS SUPPLIED WITH THE HOSE KIT).
- WITH THE EVAPORATOR TRIAL FIT COMPLETE, YOU MAY REMOVE UNIT AND LOWER IN VEHICLE.
- AFTER CRIMPING HOSES, LOCATE THE #6 A/C HOSE WITH THE STRAIGHT FITTING. LUBRICATE A #6 A/C O-RING AND THE THREADS ON THE FITTING, AND INTSTALL ON THE EXPANSION VALVE. TIGHTEN CAREFULLY. REFER TO FIGURES 3 & 3A, PAGE 7.
- LOCATE THE #10 A/C HOSE WITH THE STRAIGHT FITTING. LUBRICATE A #10 O-RING AND THE THREADS ON THE FITTING, AND INSTALL ON THE #10 LINE OF THE EVAPORATOR. TIGHTEN CAREFULLY. REFER TO FIGURES 3 & 3A, PAGE 7.
- WRAP THE #10 FITTING WITH PRESS TAPE, AND COVER ALL EXPOSED METAL SURFACES. (DO NOT WRAP THE #6 HOSE, FITTING, OR THE HEATER CORE TUBES). SEE FIGURE 3, PAGE 7.



# MINI SPACE SAVER HEAT/COOL

(31700-VBD)

WHITE HOSE INDICATES LOW-PRESSURE

BLACK HOSE INDICATES HIGH-PRESSURE

90° & STRAIGHT EVAPORATOR FITTINGS INCLUDED IN VINTAGE AIR HOSE KITS.

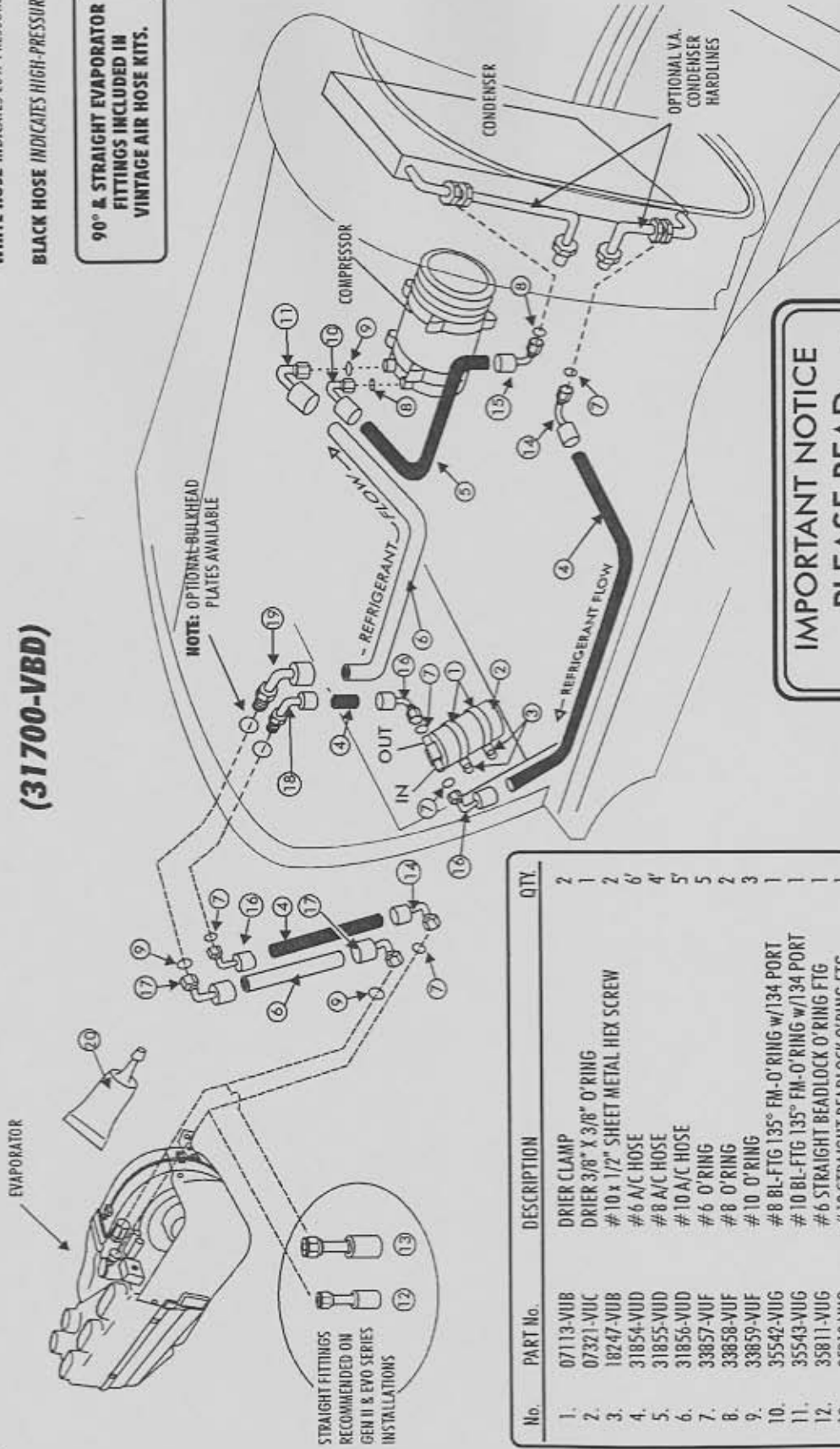

STRAIGHT FITTINGS RECOMMENDED ON GEN II & EVO SERIES INSTALLATIONS

## IMPORTANT NOTICE

### PLEASE READ

THIS HOSE KIT CONTAINS CRIMP FERRULE FITTINGS. FITTINGS MUST BE CRIMPED WITH THE APPROPRIATE 134A CRIMPING TOOL. IF YOUR HOSE KIT IS NOT A 31700-VBD REFER TO THE INSTRUCTIONS INCLUDED WITH YOUR PARTICULAR HOSE KIT FOR CRIMPING.

No.	PART No.	DESCRIPTION	QTY.
1.	07113-VUB	DRIER CLAMP	2
2.	07321-VUC	DRIER 3/8" X 3/8" O-RING	1
3.	18247-VUB	# 10 x 1/2" SHEET METAL HEX SCREW	2
4.	31854-VUD	# 6 A/C HOSE	6'
5.	31855-VUD	# 8 A/C HOSE	4'
6.	31856-VUD	# 10 A/C HOSE	5'
7.	33857-VUF	# 6 O-RING	5
8.	33858-VUF	# 8 O-RING	2
9.	33859-VUF	# 10 O-RING	3
10.	35542-VUG	# 8 BL-FTG 135° FM-O-RING w/134 PORT	1
11.	35543-VUG	# 10 BL-FTG 135° FM-O-RING w/134 PORT	1
12.	35811-VUG	# 6 STRAIGHT BEADLOCK O-RING FTG	1
13.	35813-VUG	# 10 STRAIGHT BEADLOCK O-RING FTG	1
14.	35821-VUG	# 6 BEADLOCK 45° FM-O-RING FTG	2
15.	35822-VUG	# 8 BEADLOCK 45° FM-O-RING FTG	1
16.	35831-VUG	# 6 BEADLOCK 90° FM-O-RING FTG	3
17.	35833-VUG	# 10 BEADLOCK 90° FM-O-RING FTG	2
18.	35881-VUG	# 6 BEADLOCK BULKHEAD 90° M-O-RING FTG	1
19.	35883-VUG	# 10 BEADLOCK BULKHEAD 90° M-O-RING FTG	1
20.	41117-VUP	REFRIGERANT OIL TUBE	1

**WIRING/VACUUM DIAGRAM**  
HEAT & COOL

(OPTIONAL) COMPRESSOR  
SAFETY SWITCH  
(BINARY TYPE)  
P.A. #24677-VUS

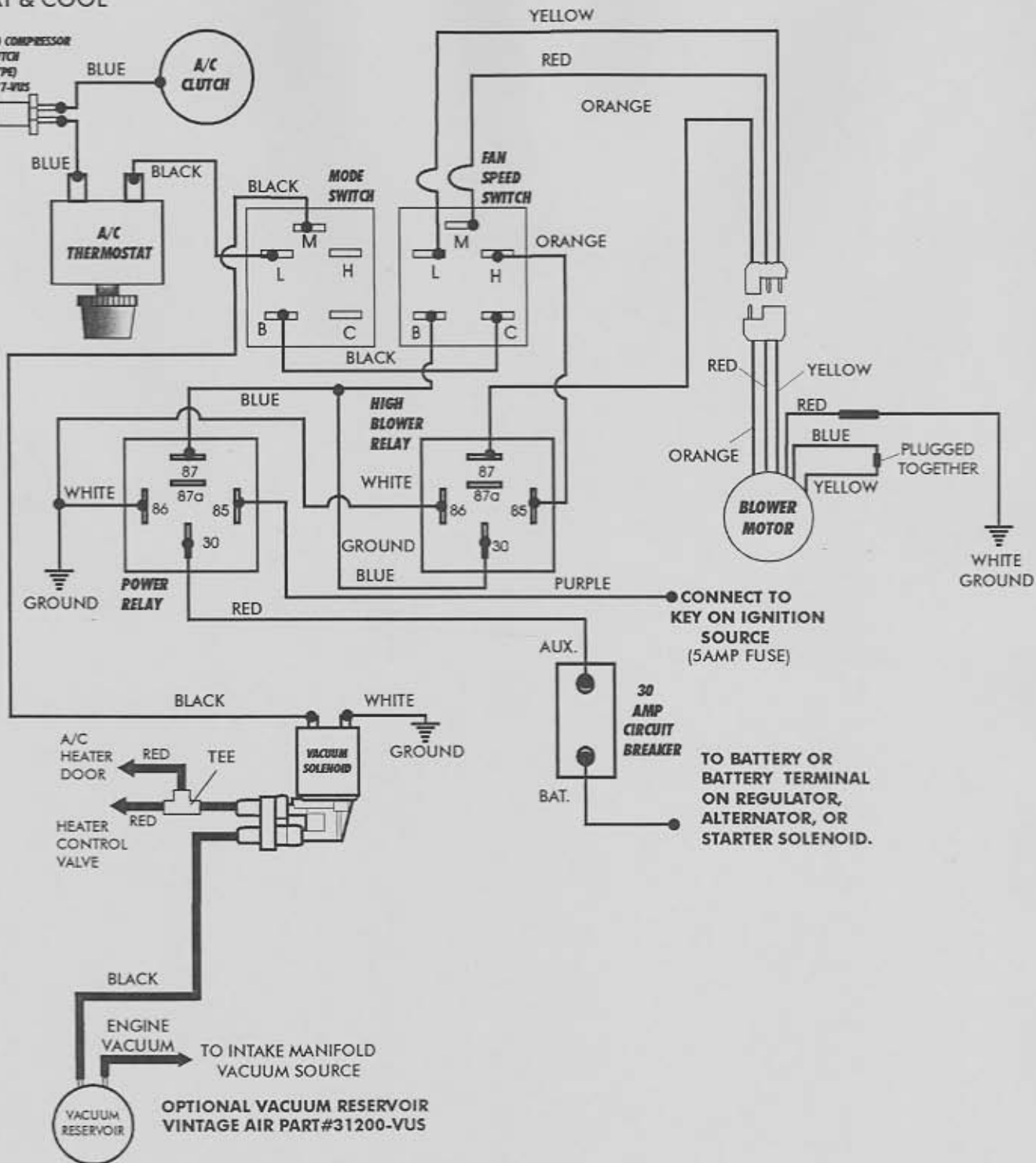

WIRES = ● — ●  
 VACUUM LINES = RED BLACK

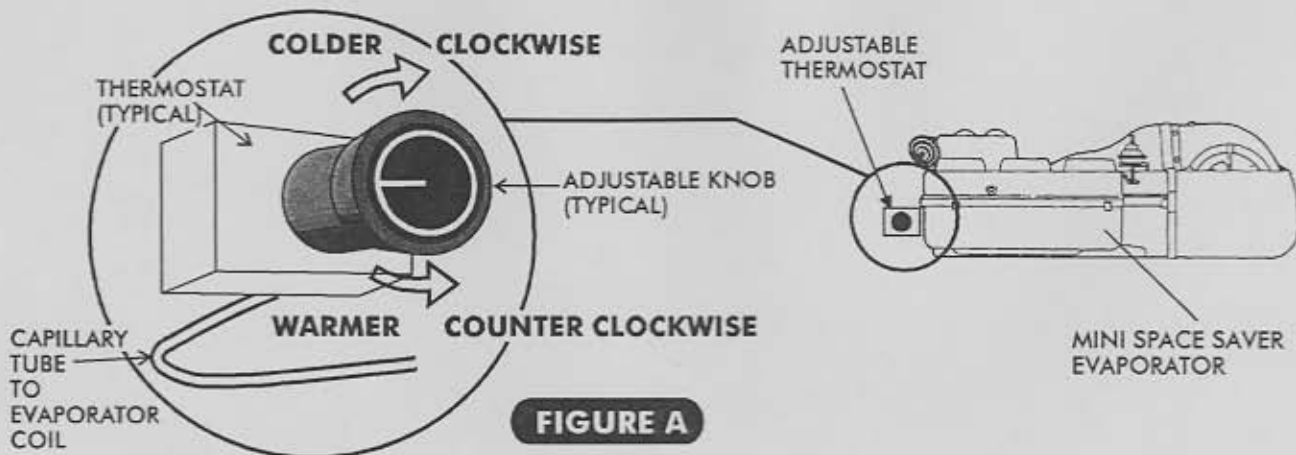

## AIR CONDITIONING ADJUSTMENTS:

- THE AIR CONDITIONER THERMOSTAT CONTROLS COIL TEMPERATURE, IT IS SHIPPED ADJUSTED FULLY COLD (CLOCKWISE), IN THE MAJORITY OF CASES THE A/C WILL OPERATE CORRECTLY AS SHIPPED.
- TURNING THE KNOB ON THE THERMOSTAT TO THE RIGHT (CLOCKWISE) MAKES THE SYSTEM OPERATE COLDER. IF THE THERMOSTAT IS SET TOO COLD THE EVAPORATOR WILL "ICE UP" - THE EVAPORATOR COIL IS RESTRICTED WITH ICE AND COLD AIR FLOW WILL BE REDUCED.
- TURNING THE KNOB TO THE LEFT (COUNTER CLOCKWISE) MAKES THE SYSTEM OPERATE WARMER. THE COMPRESSOR CLUTCH WILL CYCLE OFF FREQUENTLY AND THE A/C SYSTEM WILL NOT GET AS COOL AS IT COULD.

### ADJUSTING A/C THERMOSTAT

**1.) SYMPTOM:** THE A/C WORKS WELL AT FIRST THEN QUILTS COOLING. THE AIR FLOW FROM THE VENTS IS LOW AND THE COMPRESSOR CYCLES INFREQUENTLY.

**SOLUTION:** THE THERMOSTAT IS SET TOO COLD AND THE EVAPORATOR IS "ICING UP" AND RESTRICTING AIR FLOW. ALLOW THE ICE TO MELT AND SET THE THERMOSTAT WARMER (COUNTER CLOCKWISE) 10% OF A TURN EACH ADJUSTMENT UNTIL THE SYMPTOMS DIMINISH.

**2.) SYMPTOM:** A/C NEVER GETS COLD AND THE COMPRESSOR CLUTCH CYCLES FREQUENTLY.

**SOLUTION:** THE THERMOSTAT IS SET TOO WARM. SET THE THERMOSTAT COLDER (CLOCKWISE) 10% OF A TURN EACH ADJUSTMENT UNTIL THE COMPRESSOR CLUTCH CYCLES INFREQUENTLY. AVOID SETTING THE THERMOSTAT TOO COLD.

**3.) SYMPTOM:** THE A/C NEVER GETS COLD, SOMETIMES EVEN BLOWS HOT, AND THE A/C COMPRESSOR CLUTCH INFREQUENTLY CYCLES OFF.

**SOLUTION:** THE HEATER MAY BE ON AT ALL TIMES. CAREFULLY FEEL AROUND THE HEATER HOSES AT THE FIREWALL. THEY SHOULD BE COLD WHEN THE A/C IS ON. IF THE HOSES ARE HOT THEN:

- A) - THE HEATER CONTROL VALVE MAY BE INSTALLED BACKWARDS. CHECK THE FLOW DIRECTION ARROW ON THE VALVE AGAINST THE ILLUSTRATION IN YOUR INSTALLATION INSTRUCTIONS.
- B) - IF CABLE OPERATED: THE VALVE MAY BE MISADJUSTED.
- C) - IF VACUUM OPERATED: IT MAY BE GETTING VACUUM AT ALL TIMES (CHECK ELECTRIC SOLENOID).



## EVAPORATOR KIT PACKING LIST

 EVAPORATOR KIT  
 01000-QUX-A \_\_\_\_\_  
 01000-VUX-A \_\_\_\_\_

No.	QTY.	PART No.	DESCRIPTION	
1.	1	55302-VUE-A	EVAPORATOR SUBCASE	_____
2.	1	63250-VUE	I K KIT	_____
3.	8	06250-VUE	2 1/2" DUCT HOSE	_____
4.	1	63512-KUB	EVAPORATOR MTG. KIT	_____
5.	1	_____	CONTROL PANEL w/ WIRING	_____
6.	1	_____	VENTS	_____
		_____	OPTIONAL VENTS	_____
		_____	OPTIONAL VENTS	_____

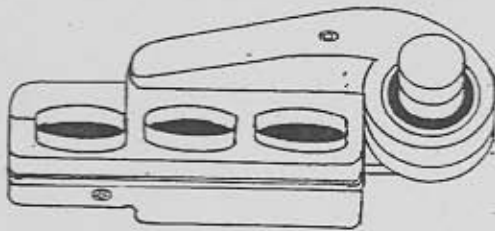
 CHECKED BY: \_\_\_\_\_  
 PACKED BY: \_\_\_\_\_  
 DATE: \_\_\_\_\_

①



②

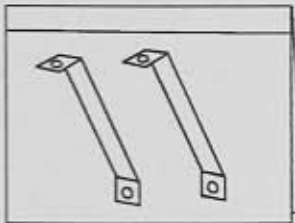

④

③



⑤

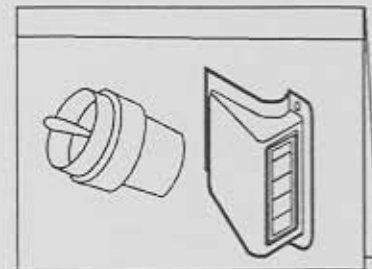

⑥